



 **Hengtai**® 亨泰



**浙江亨泰智能设备有限公司**  
ZHEJIANG HENGTAI INTELLIGENT EQUIPMENT CO.,LTD



THE ONLY SPECIALIZED MANUFACTURER IN CHINA TO PRODUCE EIGHT SERIES ZIGZAG SEWING MACHINES AND VARIOUS SPECIAL SEWING MACHINES

## 亨泰

目前中国唯一生产八大系列珠边机及各种特种机的专业厂家

1995年成立温州亨泰缝制设备有限公司;

wenzhou hengtai sewing equipment co.,ltd establish in 1995.

- ◆ 1995年生产出中国第一台GL-120珠边机;  
the first hand stitch sewing machine GL-120 produced in 1995 in China
- ◆ 2000年生产出中国第一台HT-780珠边机、HT-788珠边机;  
the first hand stitch sewing machine HT-780, HT-788 in 2000 in China
- ◆ 2002年生产出中国第一台HT-781珠边机;  
the first hand stitch sewing machine HT-781 in 2002 in China
- ◆ 2004年新厂区落成, 标志着中国特种缝纫机的又一次飞跃;  
New factory's district completion means special area sewing machine making a big improvement in 2004
- ◆ 2005年亨泰人欢庆10周年庆典之际, 全新推出新一代智能型珠边机HT-782珠边机, 并拟定新的起点;  
In the year of 2005, the company celebrate the 10<sup>th</sup>. Anniversary and researching a new generation of intelligent HT-782 hand sewing machine.
- ◆ 2006年相继开发了高级智能珠边机HT-798B, 至此弥补了珠边机不能变花样的空白;
- ◆ In the year of 2006, the company researching and developing intelligent HT-798B hand sewing machine. Making up the blank
- ◆ 2012-2013年, 开始研发HT-400毛巾横头缝边机, HT-800浴巾横头缝边机, 从而进入毛巾生产自动化行业;  
From 2012to 2013, the company begin to developing HT-400 automatic towel cross hemming machine and HT-800 automatic bath towel cross hemming machine.
- ◆ 2014年开发了HT-560程控上袖机, HT-300A电脑链式珠边机;  
In the year of 2014, the company developing HT-560 computerized sleeve setting machine and HT-300A decorative chain stitch sewing machine
- ◆ 2015年开发了HT-6100D、HT-6100F两款全自动电脑假眼机;  
In the year of 2015, researching and developing HT-6100D and HT-6100F computerized imitation buttonhole sewing machine.
- ◆ 2017年全自动毛巾双边纵缝机、全自动方巾包缝机, HT-313、HT-360双面呢暗缝机成功上市;  
In the year of 2017, researching and developing automatic double side length hemming towel machine, automatic kerchief stitching hemming towel machine, HT-313 ,HT-360 blinding stitching

**品质亨泰 誉满全球**

——强大的生产力  
 ——优秀的品质  
 ——终身维修





## 公司简介

### COMPANY INTRODUCTION

浙江亨泰智能设备有限公司前身是创立于1995年的温州市亨泰缝制设备有限公司和创立于2005年的温州市盛凯机械科技有限公司，历经二十余年的风雨兼程和顽强拼搏，两家公司于2014年实现了强强联合，今天的新亨泰，在温州瓯江口的新建厂房42000平米已投产，公司已成为了一家专业级特种智能缝纫设备，医疗智能化设备，家纺自动化设备及定制化智能设备的制造商，产品活跃在全球几十个国家和地区。

公司注重产品的创新与发展，生产工艺先进技术力量雄厚，检测设备齐全。先后获得国家发明专利2项，国家实用新型专利85项，主起草行业标准1项，参与制订行业标准1项。已全面实施信息化管理，在国内通过ISO9001质量管理体系认证，ISO14001环境管理体系认证，产品通过欧盟CE认证。公司秉承以“领先技术和卓越品质”为先导，先后获得：国家高新技术企业，市级研发中心、旗下产品被中国缝制机械协会评选为CISMA2017智慧缝制示范产品及CISMA2021主题示范产品。

展望未来，公司将“致力于推动缝制与新兴智能技术融合与应用，协助客户实现卓越突破和发展”的使命，遵循“战胜自我、追求卓越”的企业精神，秉承“以人为本、诚实守信、不断创新、质量第一”的经营理念；树立“诚信、创新、专注、共赢”的核心价值观，为打造具备可持续发展的新亨泰，不断努力前行。



跨越中的亨泰魅力无限



Zhejiang Hengtai Intelligent Device Co., Ltd. is the predecessor of Wenzhou Hengtai Sewing Equipment Co., LTD., which founded in 1995 and Wenzhou Shengkai Machinery Technology Co., LTD., which founded in 2005. After more than 20 years of trials hardships and tenacious struggle, the two companies in 2014 achieve a strong combination. Striding into new journey, Hengtai company of the new plant 42000 square meters has been put into production in Wenzhou Oujian Estuary, the company has become a world-class special sewing equipment, medical intelligent equipment, home textile automation equipment and customized intelligent equipment manufacturers, products are active in dozens of countries and regions around the world.

The company focuses on product innovation and development, strong production technology advanced technical force, complete testing equipment. It has obtained 2 national invention patents, 85 national utility model patents, drafted 1 industry standard and participated in the formulation of industry standard. Has fully implemented information management, in the domestic peers took the lead through the ISO9001 quality management system certification, ISO14001 environmental management system certification, products through the EU CE certification. Adhering to the "leading technology and excellent quality" as the guide, the company has been awarded: national high-tech enterprises, municipal R & D center, selected by the China Sewing Machine Association as Cisma2017 smart sewing demonstration products and Cisma2021 theme demonstration products.

Looking forward to the future, the company will be "committed to promoting the integration and application of sewing and emerging intelligent technology, to help customers achieve excellent breakthrough and development" mission, following the "victory over self, the pursuit of excellence" spirit of enterprise, adhering to the "people-oriented, honest and trustworthy, continuous innovation, quality first" business philosophy; Establish the core values of "integrity, innovation, focus, win-win", and constantly strive to build a new Hengtai with sustainable development

# HT-798F

## 高级电脑数控花样珠边机

COMPUTERIZED PATTERNED HAND STITCH SEWING MACHINE



### 特点

#### Features

1. 液晶触摸屏  
LCD touch screen
2. 起始倒回针功能  
Start/End backtacking
3. 转角脱线功能  
Corner stitching thread off
4. 放松缝线功能  
Thread tension loosen
5. 手自一体剪线功能  
Manual / Automatic thread trimmer
6. 采用德国EFKA电机  
Equipped with EFKA motor









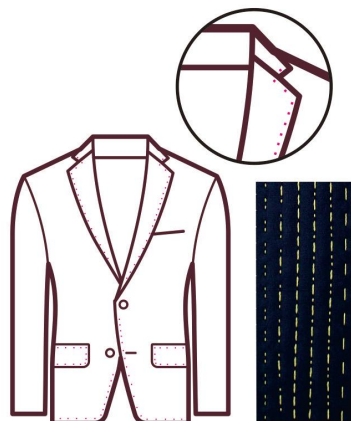







### 机器用途

用于缝制服装上的装饰性仿手工珠边，同时起到加固服装的作用，适用于西装、大衣、衬衫等，可用于不同厚度的面料。

#### Typical field of application

The machine is used for decorative hand stitching as well as reinforce stitching on the garment, such as business suit, overcoat, shirt, etc. It is suitable for various fabric thicknesses.



 仿手工缝纫机 Decorative hand stitching	 缝制速度 Sewing speed	 最大压脚提升量 Max lift of the presser foot	 缝线根数 Thread number	 使用机针 Needle	 针杆行程 Needle bar stroke	 针定位 Needle positioning	 下送料牙和交替式上送料牙 Top feed and bottom feed			
TH-798F	550 stitches/min	8 mm	1/900mm	780C 16#-23#	37 mm	A	A			
 手工线迹 Hand stitch	 盘式缝线梭 Disc stitching shuttle	 切线器 Thread trimmer	 加油方式 Oil feeding	 空气压力 Air pressure	 电机功率 Motor power	 电源 Input	 电子控制 Computer control	 可记忆花样数据 Storage number of sewing patterns		
0.5-7.0mm	A	A	锭子油 Spindle	0.5 Mpa	0.75 kW	220 V 50 Hz	A	100		

# HT-798B/G 电脑数控花样珠边机

COMPUTERIZED DECORATIVE HAND STITCH SEWING MACHINE

798B用于中薄料  
798G用于中厚料



## 特点

### Features

1. 液晶触摸屏幕  
LCD touch screen
2. 起始倒回针功能  
Start/End backtacking
3. 转角脱线功能  
Corner stitching thread off
4. 放松缝线功能  
Thread tension loosen
5. 手自一体剪线功能  
Manual / Automatic thread trimmer
6. 采用德国EFKA电机  
Equipped with EFKA motor









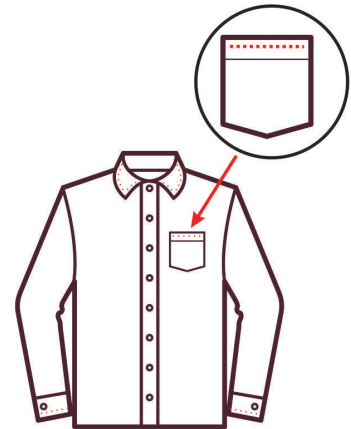







## 机器用途

用于缝制服装上的装饰性仿手工珠边，同时起到加固服装的作用，可用于不同厚度的面料。

Typical field of application

The machine is used for decorative hand stitching as well as reinforce stitching on the garment. It is suitable for various fabric thicknesses.



 仿手工缝纫机 Decorative hand stitching	 缝制速度 Sewing speed	 最大压脚提升量 Max lift of the presser foot	 缝线根数 Thread number	 使用机针 Needle	 针杆行程 Needle bar stroke	 针定位 Needle positioning	 下送料牙和交替式上送料牙 Top feed and bottom feed			
TH-798B/G	500 stitches/min	8 mm	1/900 mm	760C 16#-23#	37 mm	A	A			
 手工线迹 Hand stitch	 盘式缝线梭 Disc stitching shuttle	 切线器 Thread trimmer	 加油方式 Oil feeding	 空气压力 Air pressure	 电机功率 Motor power	 电源 Input	 电子控制 Computer control	 可记忆花样数据 Storage number of sewing patterns		
0.5-7.0mm	A	A	锭子油 Spindle	0.5 Mpa	0.75 kW	220 V 50 Hz	A	100		

# HT-795GA 高级电脑珠边机

COMPUTERIZED DECORATIVE HAND STITCH SEWING MACHINE



## 特点

### Features

1. 液晶按键屏幕  
LCD with button
2. 电脑数控  
Computer electronic controlled
3. 放松缝线功能  
Thread tension loosen
4. 手自一体剪线功能  
Manual / Automatic thread trimmer
5. 采用国产电机  
Equipped with domestic motor
6. 起始倒回针功能  
Start/End backtacking









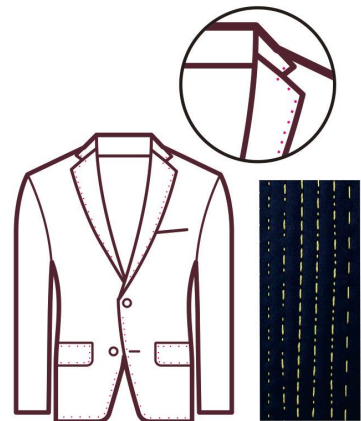







## 机器用途

用于缝制服装上的装饰性仿手工珠边，同时起到加固服装的作用，适用于时装系列等其他服装，可用于不同厚度的面料。

### Typical field of application

The machine is used for decorative hand stitching as well as reinforce stitching on the garment, suitable for fashion design series. It is suitable for various fabric thicknesses.



 仿手工缝边机 Decorative hand stitching	 缝制速度 Sewing speed	 最大压脚提升量 Max lift of the presser foot	 缝线根数 Thread number	 使用机针 Needle	 针杆行程 Needle bar stroke	 针定位 Needle positioning	 下送料牙和交替式上送料牙 Top feed and bottom feed			
TH-795GA	400 stitches/min	10 mm	1/900 mm	780C 16#-23#	37 mm	A	A			
 手工线迹 Stitch length	 盘式缝线梭 Disc stitching shuttle	 切线器 Thread trimmer	 加油方式 Oil feeding	 空气压力 Air pressure	 电机功率 Motor power	 电源 Input	 电子控制 Computer control	 可记忆花样数据 Storage number of sewing patterns		
0.5-7.0mm	A	A	锭子油 Spindle	0.5 Mpa	0.75 kW	220 V 50 Hz	A	100		

# HT-785DD/DF 电脑数控花样珠边机

COMPUTERIZED DECORATIVE HAND STITCH SEWING MACHINE



## 特点

### Features

1. 液晶触摸屏幕  
LCD touch screen
2. 起始倒回针功能  
Star/End backtacking
3. 转角脱线功能  
Corner stitching thread off
4. 放松缝线功能  
Thread tension loosen
5. 手自一体剪线功能  
Manual / Automatic thread trimmer
6. 采用国产电机  
Equipped with domestic motor

















## 机器用途

用于缝制服装上的装饰性仿手工珠边，同时起到加固服装的作用，适用于羊绒大衣、时装等，可用于不同厚度的面料。

Typical field of application

The machine is used for decorative hand stitching as well as reinforce stitching on the garment, such as cashmere coat, fashionable dress etc. It is suitable for various fabric thicknesses.



 仿手工缝纫机 Decorative hand stitching	 缝制速度 Sewing speed	 最大压脚提升量 Max lift of the presser foot	 缝线根数 Thread number	 使用机针 Needle	 针杆行程 Needle bar stroke	 针定位 Needle positioning	 下送料牙和交替式上送料牙 Top feed and bottom feed			
HT-785DD/DF	400 stitches/min	8 mm	1/900 mm	780C 16#-23#	37 mm	A	A			
 手工线迹 Hand stitch	 盘式缝线梭 Disc stitching shuttle	 切线器 Thread trimmer	 加油方式 Oil feeding	 空气压力 Air pressure	 电机功率 Motor power	 电源 Input	 电子控制 Computer control	 可记忆花样数据 Storage number of sewing patterns		
0.5-7.0mm	A	A	锭子油 Spindle	0.5 Mpa	0.55 kW	220 V 50 Hz	A	100		

# HT-300A-1 链式珠边机

DECORATIVE CHAINSTITCH SEWING MACHINE



## 特点

### Features

1. 拐角处过度平稳--不断针，不断线  
Stable corner stitch – no needle break, no thread break
2. 自动剪线功能  
Automatic thread trimmer



## 机器用途

用于缝制服装上的装饰性链式珠边，适用于休闲装、西装、西裤、皮衣、衬衫等。

### Typical field of application

The machine is used for the decorative chain stitch sewing on the garment, such as casual attire, business suit, trousers, leather clothing, leather garments, shirt, etc.

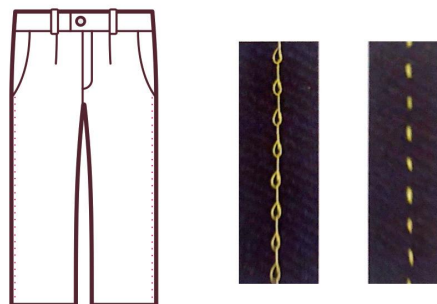

链式缝纫机 Chainstitch sewing machine	缝制速度 Sewing speed	最大压脚提升量 Max lift of the presser foot	缝线根数 Thread number	切线器 Thread trimmer	使用机针 Needle	针杆行程 Needle bar stroke	单链缝 Single chain stitch	碟式缝线梭 Butterfly shuttle
HT-300A-1	700-1600 stitches/min	6-8 mm	1	A	150-29-C 151-29-C 14#-18# 14#-18#	25.5 mm	1.5-2.5 mm	A
针定位 Needle positioning	加油方式 Oil feeding	空气压力 Air pressure	电机功率 Motor power	电源 Input	电子控制 Computer control			
A	自动加油 Automatic	0.5 Mpa	0.55 kW	220 V 50 Hz	N/A			





# HT-560DD

## 高级电脑上袖机

COMPUTERIZED SLEEVE SETTING MACHINE



### 特点

#### Features

1. 双电机上送料  
Double motor up feeding
2. 液晶按键彩屏  
LCD with buttons
3. 袖笼弧线导向功能  
Armhole curve guiding
4. 起皱值分段设定  
Wrinkle value define per segment
5. 起皱值临时加减  
Wrinkle value control by pedal



上送料带双电机示意图









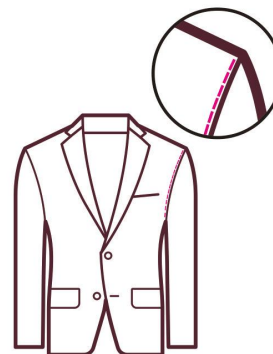







### 机器用途

用于完成服装上袖工序的专用缝纫设备，并附加起皱效果，适用于西装、大衣、休闲装、童装等。

#### Typical field of application

The machine is used to complete the sleeve setting process. Meanwhile, the corresponding wrinkle value can be adjusted. It is typically applied on business suit, overcoat, casual attire, children wear, etc.



 平缝式缝纫机 Plain stitch sewing machine	 缝制速度 Sewing speed	 针杆行程 Needle bar stroke	 最大压脚提升量 Max lift of the presser foot	 缝线根数 Thread number	 使用机针 Needle	 针定位 Needle positioning	 锁式线迹 Lock stitch	 立式旋梭 Vertical rotary hook
HT-560A/DD	4000 stitches/min	41 mm	8 mm	2	134-35 DPX35 9#-16#	A	1.5-5.5 mm	A
 切线器 Thread trimmer	 加油方式 Oil feeding	 空气压力 Air pressure	 电机功率 Motor power	 电源 Input	 电子控制 Computer control	 可记忆花样数据 Storage number of sewing patterns		
A	锭子油 Spindle	0.5 Mpa	0.75 kW	220 V 50 Hz	A	100		

# HT-550DD

## 高级电脑上袖机

COMPUTERIZED SLEEVE SETTING MACHINE



### 特点

#### Features

1. 单电机上送料  
Single motor up feeding
2. 液晶按键彩屏  
LCD with buttons
3. 袖笼弧线导向功能  
Armhole curve guiding
4. 起皱值分段设定  
Wrinkle value define per segment
5. 起皱值临时加减  
Wrinkle value control by pedal









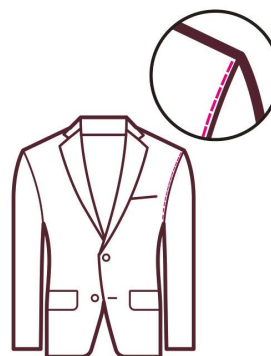







### 机器用途

用于完成服装上袖工序的专用缝纫设备，并附加起皱效果，适用于西装、大衣、休闲装、童装等。

#### Typical field of application

The machine is used to complete the sleeve setting process. Meanwhile, the corresponding wrinkle value can be adjusted. It is typically applied on business suit, overcoat, casual attire, children wear, etc.



 平缝式缝纫机 Plain stitch sewing machine	 缝制速度 Sewing speed	 针杆行程 Needle bar stroke	 最大压脚提升量 Max lift of the presser foot	 缝线根数 Thread number	 使用机针 Needle	 针定位 Needle positioning	 锁式线迹 Lock stitch	 立式旋梭 Vertical rotary hook
HT-550A/DD	4000 stitches/min	41 mm	8 mm	2	134-35 DPX35 9#-16#	A	1.5-5.5 mm	A
 切线器 Thread trimmer	 加油方式 Oil feeding	 空气压力 Air pressure	 电机功率 Motor power	 电源 Input	 电子控制 Computer control	 可记忆花样数据 Storage number of sewing patterns		
A	锭子油 Spindle	0.5 Mpa	0.75 kW	220 V 50 Hz	A	100		

# HT-160/32

## 单线电子控制暗缝套结机

COMPUTERIZED SINGLE THREAD BLIND STITCH BARTACKING MACHINE



### 特点

#### Features

1. 叠针式加固缝线迹  
Over stitch tacking thread trace
2. 自动剪线功能  
Automatic thread trimmer
3. 可随意调节针数  
Adjust stitches number freely
4. 液晶显示触摸屏  
LCD display touch panel
5. 自动抬压脚功能  
Automatic presser foot lift
6. 采用一体电控  
Integrated electronic control
7. 深浅度循环功能  
Depth circulation function

### 机器用途

用于服装的叠针式加固缝，将商标或标签缝制在毛衣、领带、外套、西装内衬、袖口及西裤等纺织品上。

#### Typical field of application

The machine is used for over stitch tacking on garments to install the labels onto the fabrics, such as sweater, tie, coat, suit lining, cuff, trousers, etc.

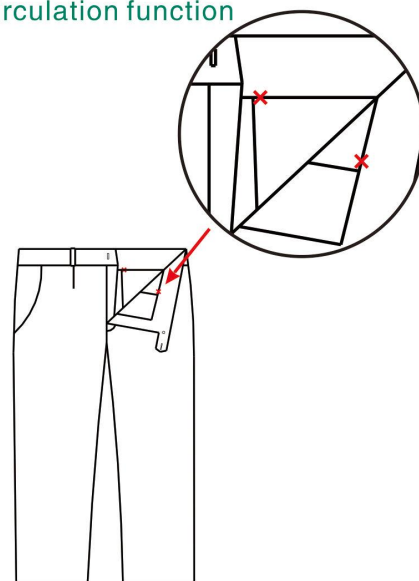

 链式工业缝纫机 Chain stitch industrial sewing machine	 缝制速度 Sewing speed	 缝线根数 Thread number	 使用机针 Needle	 单链缝 Single chain stitch	 蝶式缝线梭 Butterfly shuttle	 针定位 Needle positioning	 切线器 Thread trimmer	 电子控制 Computer control	 加油方式 Oil feeding
HT-160/32	600-1300 stitches/min	1	29BD 11#-16#	A	A	A	A	A	旋子油 Spindle
 显示器 Monitor	 空气压力 Air pressure	 电机功率 Motor power	 电源 Input	 可记忆花样数据 Storage number of sewing patterns					
A	0.5 Mpa	0.75 kW	220 V 50 Hz	100					

# HT-160/21

## 单线电子控制暗缝套结机

COMPUTERIZED SINGLE THREAD BLIND STITCH BARTACKING MACHINE



### 特点

#### Features

1. 叠针式加固缝线迹  
Over stitch tacking thread trace
2. 自动剪线功能  
Automatic thread trimmer
3. 自动抬压脚功能  
Automatic presser foot lift
4. 针数调节可选6. 8. 12针  
6.8.12 stitches can be optional
5. 采用国产电机  
Equipped with domestic motor
6. 缝纫深度可调节  
Stitching depth adjust by knob

### 机器用途

用于服装的叠针式加固缝，将商标或标签缝制在毛衣、领带、外套、西装内衬、袖口及西裤等纺织品上。

#### Typical field of application

The machine is used for over stitch tacking on garments to install the labels onto the fabrics, such as sweater, tie, coat, suit lining, cuff, trousers, etc.

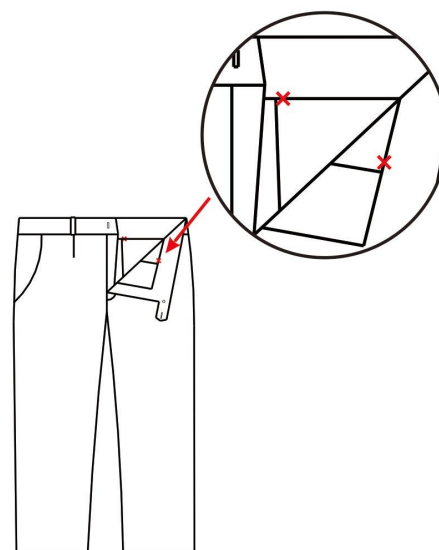

链式工业缝纫机 Chain stitch industrial sewing machine	缝制速度 Sewing speed	缝线根数 Thread number	使用机针 Needle	单链缝 Single chain stitch	蝶式缝线梭 Butterfly shuttle	针定位 Needle positioning	切线器 Thread trimmer	电子控制 Computer control	加油方式 Oil feeding
HT-160/21	600-1300 stitches/min	1	29BD 11#-16#	A	A	A	A	A	旋子油 Spindle
机械控制 Mechanical control	空气压力 Air pressure	电机功率 Motor power	电源 Input	可记忆花样数据 Storage number of sewing patterns					
A	0.5 Mpa	0.75 kW	220 V 50 Hz	3					

# HT-697AE

## 攀登切割机

LINING AND SHOULDER PAD ONTO ARMHOLE - ATTACHING AND TRIMMING MACHINE



### 特点

#### Features

1. 自动切刀装置 – 切除缝合余料 Automatic trimmer for remaining material
2. 电脑数控送料差动 Electronic top / bottom differential feeding
3. 自动或手动松线装置 – 使线迹适应垫肩厚度 Automatic / Manual thread loosen – adapting the thread trace to the thickness
4. 带针交替上送料 Alternating up feeding with needle
5. 液晶触摸屏 LCD touch screen
6. 电脑数控调节针距、起皱值、夹线 Electronic adjust needle distance, Wrinkle value, thread clamp











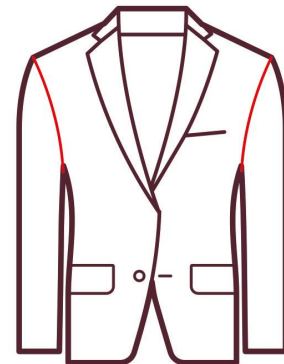



### 机器用途

用于缝合西装袖笼与棉条、垫肩，完美切除缝合余料。

### Typical field of application

The machine is used for attaching the shoulder pad and armhole lining onto the armhole, as well as trimming the remaining material perfectly.



 刀式工业缝纫机 Trimming machine	 缝制速度 Sewing speed	 缝线根数 Thread number	 使用机针 Needle	 锁式线迹 Lock stitch	 卧式梭芯 Horizontal type bobbin	 切线器 Thread trimmer	 下送料牙, 针送料和交替式上送料牙 Under feed dog, Needle feeding and alternate upper feed dog
HT-697AE	1500stitches/min	2	190R 130#	2.0-9.0 mm	A	A	A
 加油方式 Oil feeding	 电机功率 Motor power	 电源 Input					
锭子油 Spindle	0.75 kW	220 V 50 Hz					

# HT-697BE

## 上袖里机

SLEEVE LINING SEWING MACHINE



### 特点

#### Features

1. 电脑数控送料差动

Electronic top / bottom differential feeding

2. 自动或手动松线装置 – 使线迹适应垫肩厚度

Automatic / Manual thread loosen – adapting the thread trace to the thickness

3. 带针交替上送料

Alternating up feeding with needle

4. 液晶触摸屏

LCD touch screen

5. 电脑数控调节针距、起皱值、夹线

Electronic adjust needle distance, Wrinkle value, thread clamp











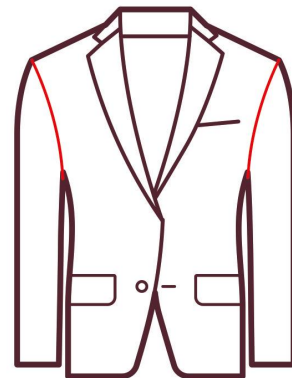



### 机器用途

用于西装缝合里衬和棉条。

Typical field of application

The machine is used for sewing the sleeve lining and armhole lining.



 刀式工业缝纫机 Trimming machine	 缝制速度 Sewing speed	 缝线根数 Thread number	 使用机针 Needle	 锁式线迹 Lock stitch	 卧式线芯 Horizontal type bobbin	 切线器 Thread trimmer	 下送料牙, 针送料和交替式上送料牙 Under feed dog, Needle feeding and alternate upper feed dog
HT-697BE	1500stitches/min	2	190R 130#	2.0-9.0 mm	A	A	A
 加油方式 Oil feeding	 电机功率 Motor power	 电源 Input					
锭子油 Spindle	0.75 kW	220 V 50 Hz					

# HT-313A

## 双面呢暗缝机

DOUBLE FACE CASHMERE BLIND STITCH MACHINE



### 特点

#### Features

1. 定位装置进料功能

Positioning system feeding

2. 双线弯针人字暗缝

Double thread curved needle zig-zag stitch

### 机器用途

用于双面呢面料的缝合、拼接，适用于双面呢大衣。采用暗缝工艺，缝制后织物表面看不到缝纫痕迹。

#### Typical field of application

The machine is used for the joint part stitching of double face cashmere, typically the cashmere overcoat. Using the Blind stitch technique is to hide the thread trace after sewing.

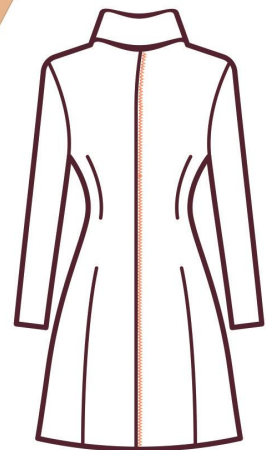
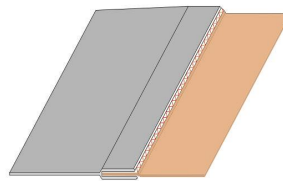

双面呢暗缝机 Double face cashmere machine	缝制速度 Sewing speed	缝线根数 Thread number	使用机针 Needle	锁式线迹 Lock stitch	立式旋梭 Vertical rotary hook	针定位 Needle positioning	手动切线器 Hand trimmer	加油方式 Oil feeding	空气压力 Air pressure
HT-313A	800-1500 stitches/min	2	1717DC	A	A	A	A	梭子油 Spindle	0.5 Mpa
电机功率 Motor power	电源 Input	电子控制 Computer control							
0.75 kW	220 V 50 Hz	A							

# HT-360A 双面呢暗缝机

DOUBLE FACE CASHMERE MACHINE



## 特点

### Features

1. 单/双包卷边筒装置

Single/double rolling cylinder feeding

2. 双线弯针人字暗缝

Double thread curved needle zig-zag stitch













## 机器用途

用于双面尼面料的边缘缝制，如门襟、下摆、领边、袖口、袋口等。采用暗缝工艺，缝制线迹不外露。

Typical field of application

The machine is used for the edge sewing on double face cashmere, such as fly front, hem, collar edge, sleeve opening, pocket edge, etc. Using the Blind stitch technique is to hide the thread trace after sewing.



 双面呢暗缝机 Double face cashmere machine	 缝制速度 Sewing speed	 缝线根数 Thread number	 使用机针 Needle	 锁式线迹 Lock stitch	 立式旋梭 Vertical rotary hook	 针定位 Needle positioning	 手动切线器 Hand trimmer	 加油方式 Oil feeding	 空气压力 Air pressure
HT-360A	800-1500 stitches/min	2	1717DC	A	A	A	A	梭子油 Spindle	0.5 Mpa
 电机功率 Motor power	 电源 Input	 电子控制 Computer control							
0.75 kW	220 V 50 Hz	A							

# HT-360AT 双面呢暗缝机

DOUBLE FACE CASHMERE MACHINE

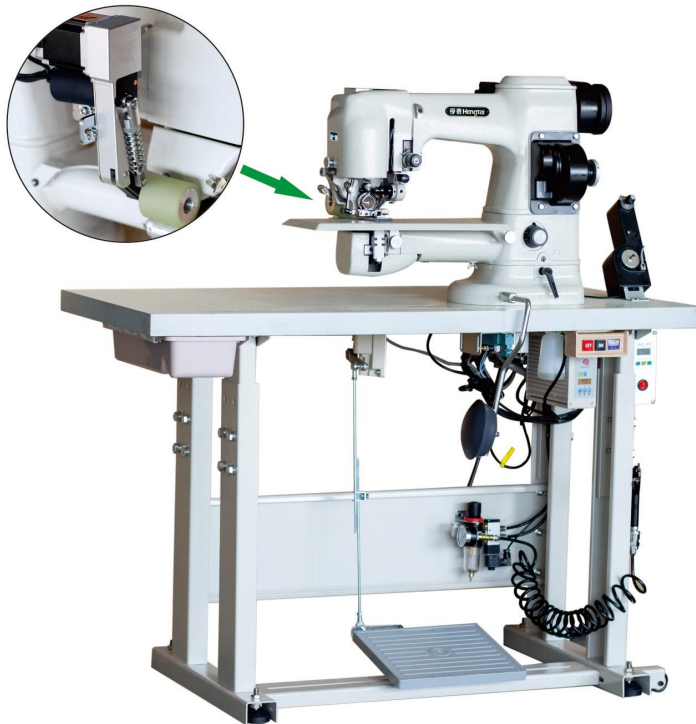

## 特点

### Features

1. 单/双包卷边筒装置

Single/double rolling cylinder feeding

2. 双线弯针人字暗缝

Double thread curved needle zig-zag stitch

3. 平整布料，使缝制效果更加美观

Stable materials, increase perfect stitching effect













## 机器用途

用于双面尼面料的边缘缝制，如门襟、下摆、领边、袖口、袋口等。采用暗缝工艺，缝制线迹不外露。

Typical field of application

The machine is used for the edge sewing on double face cashmere, such as fly front, hem, collar edge, sleeve opening, pocket edge, etc. Using the Blind stitch technique is to hide the thread trace after sewing.



 双面呢暗缝机 Double face cashmere machine	 缝制速度 Sewing speed	 缝线根数 Thread number	 使用机针 Needle	 锁式线迹 Lock stitch	 立式旋梭 Vertical rotary hook	 针定位 Needle positioning	 手动切线器 Hand trimmer	 加油方式 Oil feeding	 空气压力 Air pressure
HT-360AT	800-1500 stitches/min	2	1717DC	A	A	A	A	梭子油 Spindle	0.5 Mpa
 电机功率 Motor power	 电源 Input	 电子控制 Computer control							
0.75 kW	220 V 50 Hz	A							





# HT-1000

## 单针平面复衬机

SINGLE NEEDLE FLAT-BED TACKING AND BASTING MACHINE



### 特点

#### Features

1. 自动剪线功能

Automatic thread trimmer

2. 伺服马达

Servomotor

3. 脚踏控制单针点缝

Single needle tacking by pedal

4. 自动供油

Automatic oil feeding

5. 自动抬压脚功能

Automatic presser foot lift









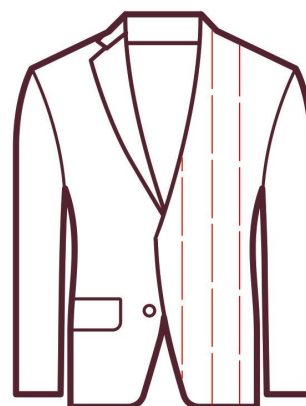





### 机器用途

用于服装的平面复衬工序，适用于西服、大衣、休闲装等。

Typical field of application

The machine is used for the flat-bed tacking and basting process. It is applicable for business suit, over coat, casual attire, etc.



 平缝式缝纫机 Plain stitch sewing machine	 缝制速度 Sewing speed	 针杆行程 Needle bar stroke	 最大压脚提升量 Max lift of the presser foot	 缝线根数 Thread number	 使用机针 Needle	 针定位 Needle positioning	 锁式线迹 Lock stitch	 立式旋梭 Vertical rotary hook
HT-1000	800 stitches/min	30.2 mm	15 mm	2	DBX1 11#-14#	A	A	A
 切线器 Thread trimmer	 加油方式 Oil feeding	 电机功率 Motor power	 电源 Input	 电子控制 Computer control				
A	自动加油 Automatic	0.55 kW	220 V 50 Hz	N/A				

# HT-333A 单针筒式复衬机

SINGLE NEEDLE CYLINDER BASTING MACHINE FOR SHOULDER PAD



## 特点

### Features

1. 缝线跟随缝料滑移  
Thread shifting along with workpiece
2. 缝线张力控制  
Thread tension adjustable
3. 脚踏控制单针点缝  
Single needle tacking by pedal
4. 自动剪线功能  
Automatic thread trimmer









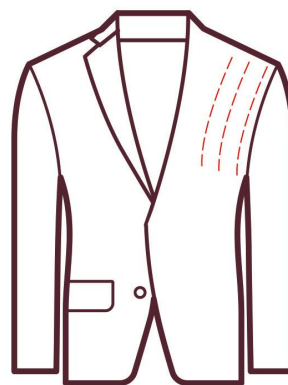





## 机器用途

用于临时固定服装的肩垫，可做点缝、疏缝，适用于西装、大衣等。

Typical field of application

The machine is used for tacking and basting on the shoulder pads of business suit, overcoat, etc.



 平缝式缝纫机 Plain stitch sewing machine	 缝制速度 Sewing speed	 最大压脚提升量 Max lift of the presser foot	 缝线根数 Thread number	 切线器 Thread trimmer	 使用机针 Needle	 针杆行程 Needle bar stroke	 针定位 Needle positioning	 锁式线迹 Lock stitch
HT-333A	1100 stitches/min	19 mm	2	A	MTX190R 14#-16#	35 mm	A	A
 立式旋梭 Vertical rotary hook	 加油方式 Oil feeding	 电机功率 Motor power	 电源 Input	 电子控制 Computer control				
A	旋子油 Spindle	0.55 kW	220 V 50 Hz	A				

# HT-2438N-7 手巾袋 暗缝人字机

BLIND STITCH SEWING MACHINE FOR POCKET ZIG-ZAG WAY



## 特点

### Features

1. 人字形半暗缝线迹  
Zig-Zag thread trace hidden after sewing
2. 倒缝直线线迹  
Straight thread trace on backtacking
3. 自动剪线功能  
Automatic thread trimmer
4. 在高速运行时安静、平稳  
Noiseless and stable at high speed









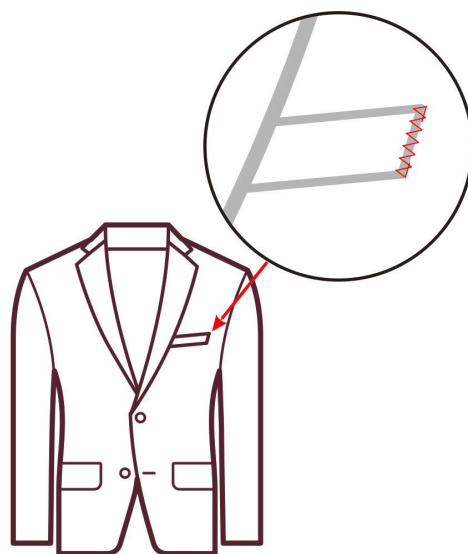





## 机器用途

用于前胸手巾袋的边缘缝制和商标缝制，适用于西装、职业装等。

Typical field of application

The machine is used for the pocket edge sewing or label sewing on the business suit and so on.



 平缝式缝纫机 Plain stitch sewing machine	 缝制速度 Sewing speed	 最大压脚提升量 Max lift of the presser foot	 缝线根数 Thread number	 切线器 Thread trimmer	 使用机针 Needle	 曲折缝 Zig-Zag sewing	 立式旋梭 Vertical rotary hook	 锁式线迹 Lock stitch
HT-2438N-7	2200 stitches/min	6-8 mm	2	A	PFX134EL 12#-16#	3 mm	A	A
 下送料牙 Bottom feed	 显示器 Monitor	 加油方式 Oil feeding	 空气压力 Air pressure	 电机功率 Motor power	 电源 Input			
A	A	自动加油 Automatic	0.5 Mpa	0.75 kW	220 V 50 Hz			

# HT-2587

## 单针单线链式临缝机

SINGLE NEEDLE SINGLE THREAD CHAIN STITCH BASTING MACHINE



### 特点

#### Features

1. 单线链式线迹  
Single thread chain stitch thread trace
2. 不需要底线  
No need for bobbin thread
3. 缝制完成后易拆线  
Easy stitch removal after sewing
4. 上下同步送料—保证缝制均匀  
Simultaneous feeding – uniformly sewing

### 机器用途

用于服装门襟的边缘临时固定，使缝制更精确，是高端服装生产过程中必不可少的工艺，适用于西服、大衣等。

#### Typical field of application

The machine is used for basting stitch on the fly front. It is the essential technique to improve sewing accuracy and preciseness, typically applied on business suit, overcoat, etc.

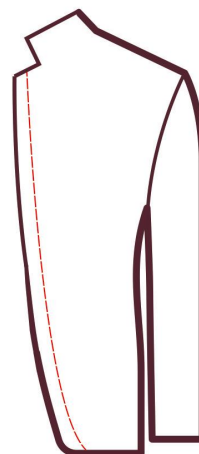

 链缝缝纫机 Chain stitching	 缝制速度 Sewing speed	 缝线根数 Thread number	 使用机针 Needle	 单链缝 Single chain stitch	 碟式缝线梭 Butterfly shuttle	 最大压脚提升量 Max lift of the presser foot	 下送料牙和交替式上送料牙 Top feed and bottom feed
HT-2587	1800 stitches/min	1	TVX7 11#-14#	8 mm	A	5-12 mm	A
 加油方式 Oil feeding	 电机功率 Motor power	 电源 Input	 电子控制 Computer control				
自动加油 Automatic	0.55 kW	220 V 50 Hz	A				

# HT-103N-3

## 高速上下层止口机

EDGE TRIMMING MACHINE



### 特点

#### Features

1. 可用于不同厚度面料

Applicable for different fabric thicknesses

2. 全自动供油

Automatic oil feeding

3. 标准止口为3毫米

Standard edge: 3 mm









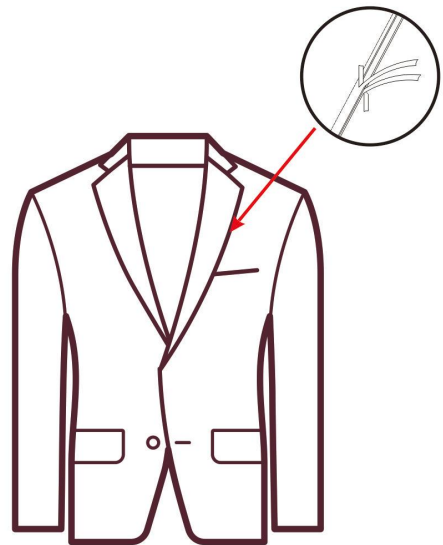

### 机器用途

用于缝制门襟、领襟的上下止口，适用于西装、大衣等。

#### Typical field of application

The machine is used for standard front edge trimming in the fly area of business suit, overcoat, etc.



 刀式工业缝纫机 Trimming machine	 缝制速度 Sewing speed	 最大压脚提升量 Max lift of the presser foot	 止口宽度 Trimming width	 加油方式 Oil feeding	 电机功率 Motor power	 电源 Input	 电子控制 Computer control		
HT-103N-3	2000 stitches/min	6/10 mm	3 mm	自动加油 Automatic	0.55 kW	220 V 50 Hz	A		



### professional sewing

HENGTAI products ( the structure and advantages of main products)

连续23年亨泰珠边机全球销量第一。  
向您推荐我们引以为豪的自动化产品系列……

## HT-1400 自动打条机 AUTOMATIC STRAPPING MACHINE

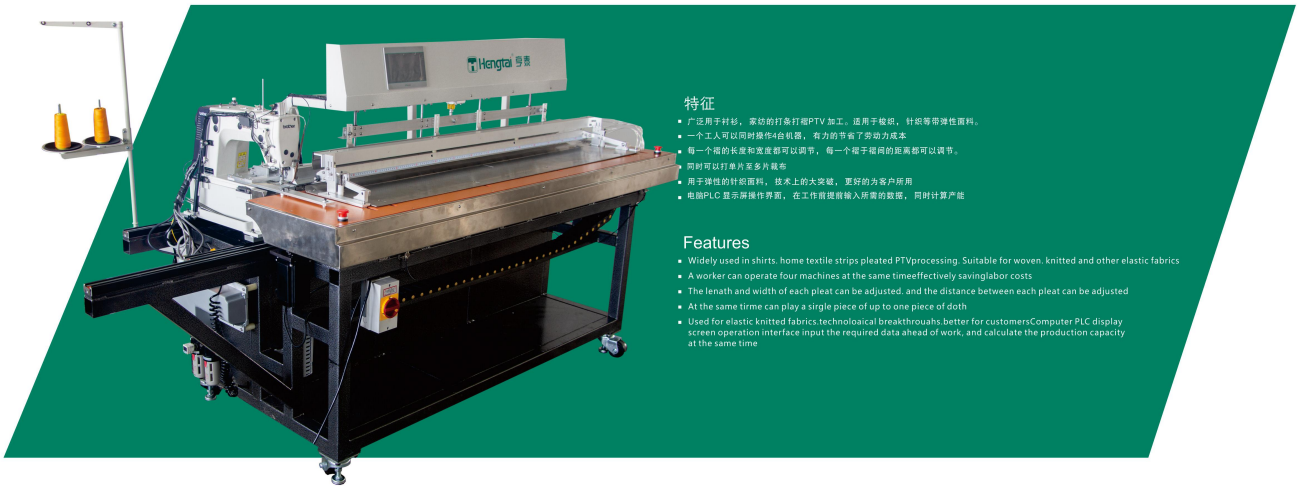

### 特征

- 广泛应用于衬衫、家纺的打条打褶PTV加工。适用于梭织、针织等弹性面料。
- 一个工人可以同时操作4台机器，有力的节省了劳动力成本
- 每一个褶的长度和宽度都可以调节，每一个褶子褶间的距离都可以调节。
- 可以同时打单片至多片裁布
- 用于弹性的针织面料，技术上的大突破，更好的为客户所用
- 电脑PLC显示屏操作界面，在工作前提前输入所需的数据，同时计算产能

### Features

- Widely used in shirts, home textile strips pleated PTV processing. Suitable for woven, knitted and other elastic fabrics
- A worker can operate four machines at the same time effectively saving labor costs
- The length and width of each pleat can be adjusted, and the distance between each pleat can be adjusted
- At the same time can play a single piece of up to one piece of cloth
- Used for elastic knitted fabrics technological breakthroughs, better for customers Computer PLC display screen operation interface input the required data ahead of work, and calculate the production capacity at the same time

型号	HT-1400 自动打条机
最长可调的打条长度	0MM-1400MM
最长可调的打条宽度	3MM-50MM
电压功率	AC 220V, 50/60HZ / 1000w
机器尺寸	2520mm×1010mm×1370mm
标准气压	5kg/cm²
净重	422kg

MODEL	HT-1400
Maximum adjustable punch width	0MM-1400MM
Maximum adjustable strip length	3MM-50MM
Voltage/Power	AC 220V, 50/60HZ / 1000w
Machine size	2520mm×1010mm×1370mm
Standard Pressure	5kg/cm²
Net Weight	422kg



### professional sewing

HENGTAI products ( the structure and advantages of main products)

连续23年亨泰珠边机全球销量第一。  
向您推荐我们引以为豪的自动化产品系列……

## HT-1600 自动打条机 AUTOMATIC STRAPPING MACHINE



#### 特征

- 广泛应用于衬衫、家纺的打条打褶PTV加工。适用于梭织、针织等带弹性面料。
- 一个工人可以同时操作4台机器，有力的节省了劳动力成本
- 每一个褶的长度和宽度都可以调节，每一个褶子之间的距离都可以调节。
- 同时可以打单片至多片裁布
- 用于弹性的针织面料，技术上的大突破，更好的为客户所用
- 电脑PLC显示屏操作界面，在工作前预先输入所需的数据，同时计算产能

#### Features

- Widely used in shirts, home textile strips pleated PTV processing. Suitable for woven, knitted and other elastic fabrics
- A worker can operate four machines at the same time effectively saving labor costs
- The length and width of each pleat can be adjusted, and the distance between each pleat can be adjusted
- At the same time can play a single piece of up to one piece of cloth
- Used for elastic knitted fabrics technological breakthroughs, better for customers Computer PLC display screen operation interface input the required data ahead of work, and calculate the production capacity at the same time

型号	HT-1600 自动打条机
最长可调的打条长度	0MM-1600MM
最长可调的打条宽度	3MM-500MM
电压/功率	AC 220V, 50/60HZ / 1000w
机器尺寸	2950mm×1000mm×1310mm
标准气压	5kg/cm <sup>2</sup>
净重	400kg

MODEL	HT-1600
Maximum adjustable punch width	0MM-1600MM
Maximum adjustable strip length	3MM-500MM
Voltage/Power	AC 220V, 50/60HZ / 1000w
Machine size	2950mm×1000mm×1310mm
Standard Pressure	5kg/cm <sup>2</sup>
Net Weight	400Kg



**浙江亨泰智能设备有限公司**

地 址：浙江温州市海洋经济发展区瓯帆路373号  
销售部电话：0577-86293300  
外贸部电话：0577-86293707  
客服部电话：0577-86090111  
热 线 电 话：400-699-2600  
传 真：0577-86293311  
网 址：[Http://www.hengtaisewing.com](http://www.hengtaisewing.com)

